



Color Variants

BSP270131

BSP270101

BSP270111

Included accessories

1 x outlet hose 3m.

1 x grid.

1 x pluggable meat probe.

1 x water inlet hose 3m.

1 x STS tray.

punched.

40 mm deep.

1 x STS tray.

Optional accessories

BA010301

BA020360

BA020370

BA020380

BA020390

CLS10040

Cleaning cartridges, set of 4

CLS30040

GN010330

GN114130

Stainless steel cooking insert

GN114230

Stainless steel cooking insert

GN124130

Stainless steel cooking insert

GN124230

Stainless steel cooking insert

GN340230

Non-stick aluminum cast-iron roaster

Installation Accessories

GF111100

GF121110

GZ010011

Extension for inlet and outlet (78" long)

Product Variants

BSP271131

Product Features

Product color

Construction type

Built-in

Door opening

Lateral

Required cutout size (HxWxD) (mm)

450-450 x 560-560 x 550

Overall appliance dimensions (HxWxD)

(mm)

455 x 590 x 540

Product packaging dimensions

(HxWxD) (mm)

580 x 660 x 690

Control Panel Material

Door Material - primary cavity

Glass

Net weight (kg)

46.069

Approval certificates

Australia Standards, CCC, CE, China,

China ROHS 20, Eurasian, G-Mark,

Ukraine, VDE

Power cord length (cm)

175

Cooking mode

Broil and steam, Defrost, fermentation,

Hot Air, Hot air + steam 100%, Hot air

+ steam 30%, Hot air + steam 60%,

Hot air + steam 80%, Hot air broiling,

Regeneration, Sous-vide cooking

Time-setting Options

Consumption and connection features

Watts (W)

Current (A)

16

Volts (V)

220-240

Frequency (Hz)

50

Plug type

Gardy plug w/ earthing

Connecting cable type

Approval certificates

Australia Standards, CCC, CE, China,

China ROHS 20, Eurasian, G-Mark,

Ukraine, VDE

UPC code

Product color

Alternative colors available

BSP270101, BSP270111

Energy source

Electric

Current (A)

16

Volts (V)

220-240

Frequency (Hz)

50

Approval certificates

Australia Standards, CCC, CE, China,

China ROHS 20, Eurasian, G-Mark,

Ukraine, VDE

Power Cord Length

Plug type

Gardy plug w/ earthing

Overall appliance dimensions (HxWxD)

(in)

Required cutout size (HxWxD) (in)

Product packaging dimensions

(HxWxD) (in)

Net weight (lbs)

102.000

Gross weight (lbs)

107

2020-03-25

Page 1

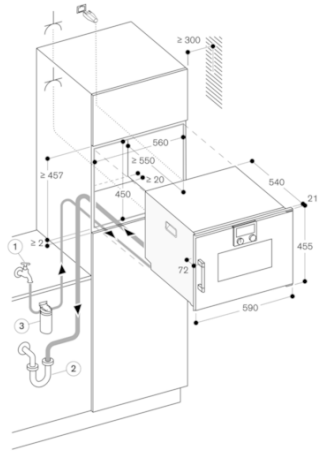

Outlet
Measurements in mm

Side view of BSP 260/270 over BOP

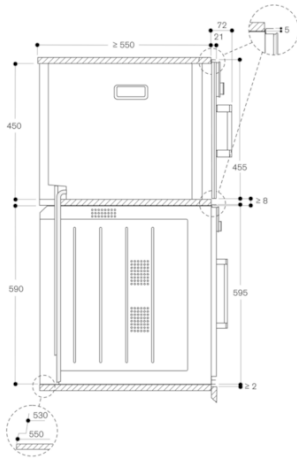

Measurements in mm

Rear view

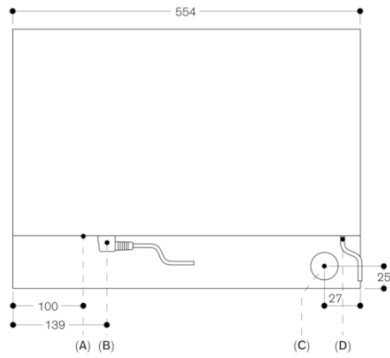

- A: LAN connection
- B: Electric connection box
- C: Water drainage
- D: Cold water connection

Measurements in mm

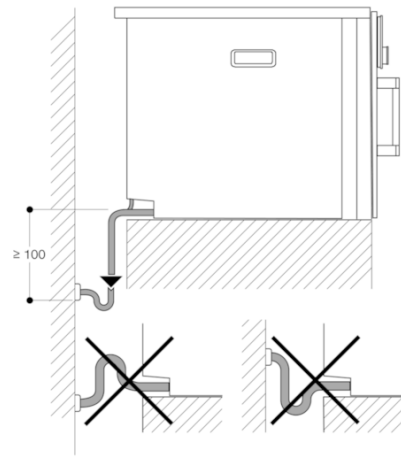

Measurements in mm