



SUB-ZERO INTEGRATED REFRIGERATION INTEGRATED MODELS

Integrated Refrigeration

With custom front panels and hardware, Sub-Zero invented integrated columns, tall and drawer models that disappear into the decor. Integrated units fit flush with other cabinets, making integrated refrigeration as practical and beautiful in the master suite, bar or theatre room as in the kitchen.

KEY FEATURES

- Custom front panels and hardware allow for infinite design options.
- Point-of-use refrigeration that can be placed anywhere in the home.
- Dual refrigeration; two compressors preserve food's goodness in self-contained compartments.
- Energy efficient. All models rated A+ or higher.
- Star-K certified.

INTEGRATED MODELS

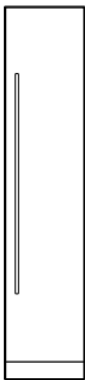

ICBIC-18FI

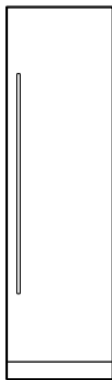

ICBIC-24R
ICBIC-24FI

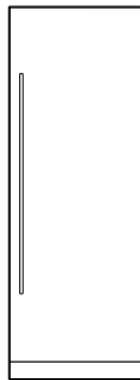

ICBIC-30RID
ICBIC-30FI



ICBIC-36RID

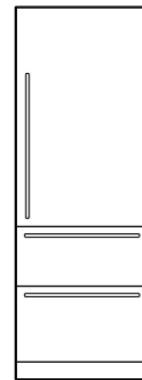

ICBIT-30RID
ICBIT-30CIID

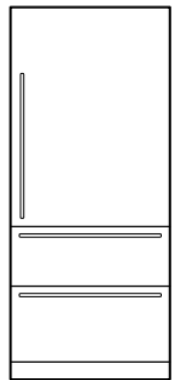

ICBIT-36CIID

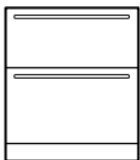

ICBID-30RP
ICBID-30CI



SUB-ZERO INTEGRATED REFRIGERATION INTEGRATED MODELS | OPENING DIMENSIONS

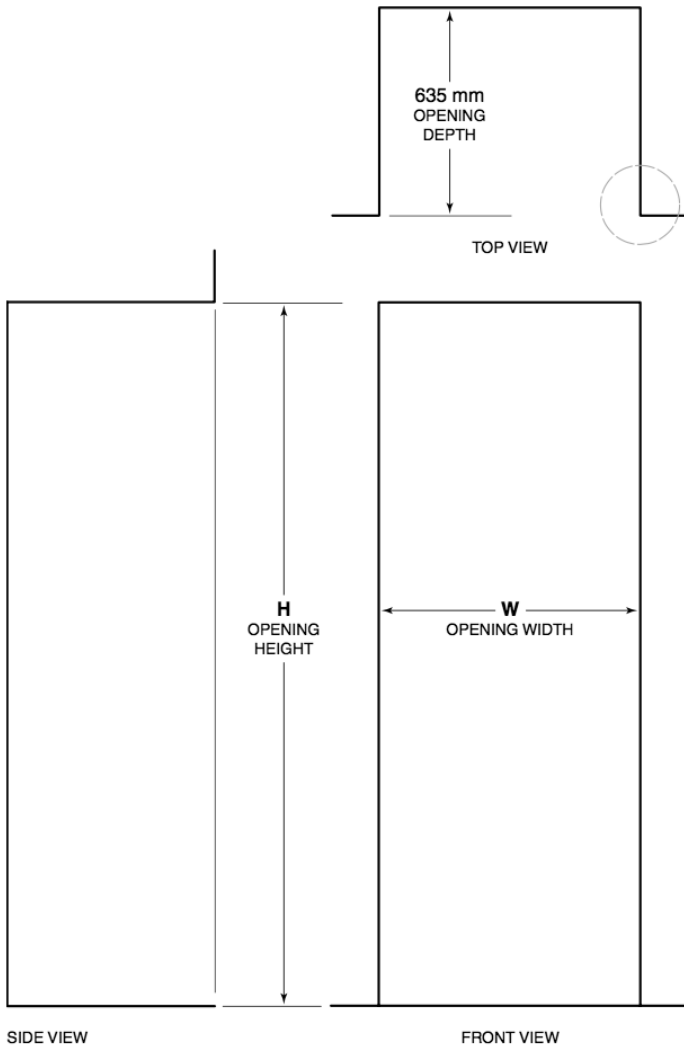

OPENING DIMENSIONS		
COLUMN	W	H
ICBIC-18FI	457 mm	2134 mm
ICBIC-24R, ICBIC-24FI	610 mm	2134 mm
ICBIC-30RID, ICBIC-30FI	762 mm	2134 mm
ICBIC-36RID	914 mm	2134 mm
TALL	W	H
ICBIT-30RID, ICBIT-30CIID	762 mm	2134 mm
ICBIT-36CIID	914 mm	2134 mm
DRAWER	W	H
ICBID-30RP, ICBID-30CI	762 mm	876 mm

The depth of each integrated model is 610 mm. Allow for panel thickness when planning the finished opening depth. A minimum 89 mm finished return is required on all sides of the opening. Framed cabinets will require additional finished filler material behind the face frame for a proper installation. Refer to the illustration.

DUAL INSTALLATION

When installing two units side by side in a dual installation, the opening width is the width of the two units added together. A dual installation kit will be required for this installation. If a dual installation kit is not specified, a minimum 51 mm filler strip is required between units.

Dual installation kits are available through an authorized Sub-Zero dealer. For questions regarding the installation, contact your authorized Sub-Zero dealer.

SIDE VIEW

FRONT VIEW

NOTE: 89 mm finished returns will be visible and should be finished to match cabinetry.

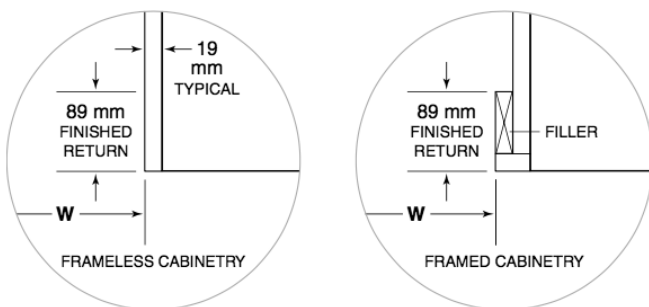



SUB-ZERO INTEGRATED REFRIGERATION INTEGRATED MODELS

Electrical

The electrical supply must be located within the shaded area shown in the illustration and chart below. A separate circuit, servicing only this appliance is required. A ground fault circuit interrupter (GFCI) is not recommended and may cause interruption of operation.

Installation must comply with all applicable electrical codes.

ELECTRICAL REQUIREMENTS	
Power Supply	220-240 V AC, 50/60 Hz
Circuit Breaker	10 amp
Receptacle	grounding-type (earthed)

ELECTRICAL SUPPLY LOCATION	
WIDTH	A
457 mm Model	152 mm
610 mm Model	241 mm
762 mm Model	318 mm
914 mm Model	394 mm

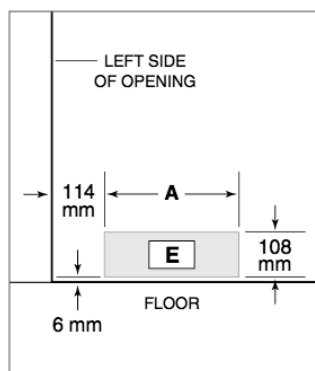

Electrical supply location.

Plumbing

The water supply line should be located within the shaded area shown in the illustration below. The water supply line should be connected to the house supply with an easily accessible shut-off valve. Do not use self-piercing valves. The water supply line must not interfere with installation of the anti-tip bracket.

A reverse osmosis system can be used provided there is constant water pressure of 2.4–8.3 bar supplied to the unit at all times. A copper line is not recommended for this application.

Installation must comply with all applicable plumbing codes.

PLUMBING REQUIREMENTS	
Water Supply Line	6.35 mm OD copper line, braided stainless steel, or PEX tubing
Water Pressure	2.4–8.3 bar
Excess Water Line for Connection	.9 m

WATER SUPPLY LOCATION	
WIDTH	A
457 mm Model	76 mm
610 mm Model	140 mm
762 mm Model	152 mm
914 mm Model	229 mm

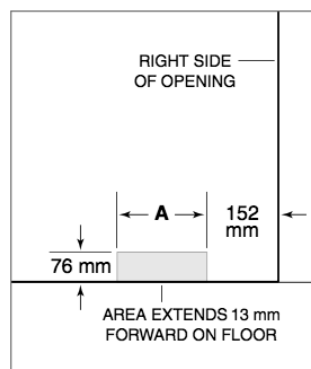

Water supply location.



SUB-ZERO INTEGRATED REFRIGERATION INTEGRATED MODELS

Specifications

INTERIOR CAPACITY			
COLUMN	R (L)	F (L)	
ICBIC-18FI		230	
ICBIC-24R	352		
ICBIC-24FI		338	
ICBIC-30RID	475		
ICBIC-30FI		415	
ICBIC-36RID	590		
TALL	R (L)	F (L)	
ICBIT-30RID	397		
ICBIT-30CIID	295	95	
ICBIT-36CIID	359	130	
DRAWER	R (L)	F (L)	
ICBID-30RP	138		
ICBID-30CI	58	39	

IMPORTANT NOTE: Overall dimensions do not include panels or handles. Dimensions will vary with panel thickness.

Overall Dimensions

COLUMN

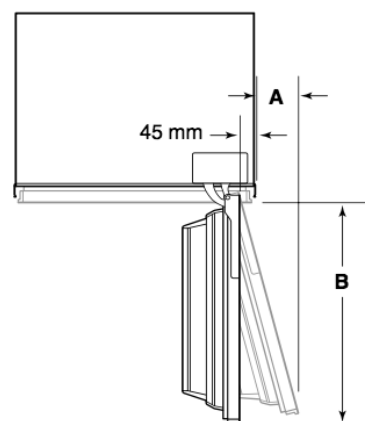
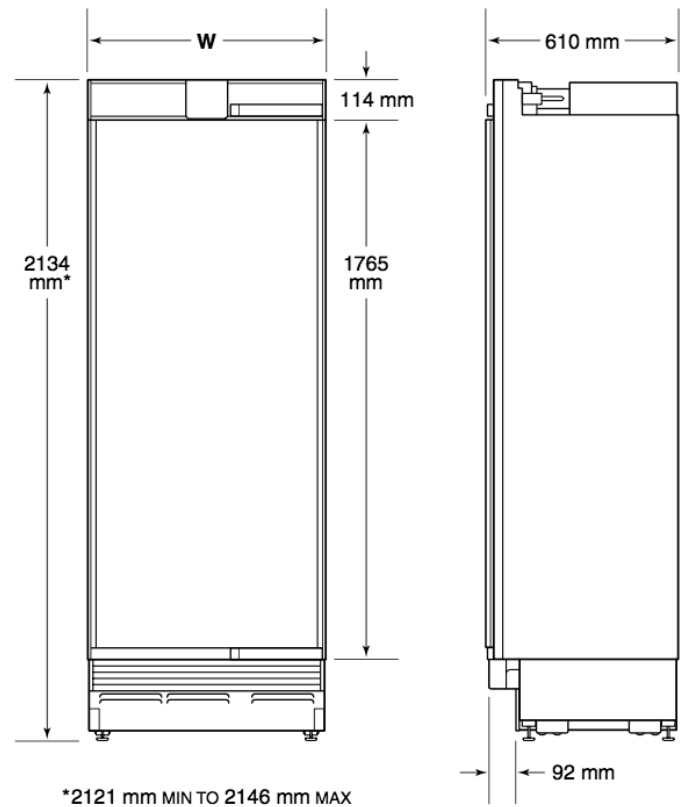

COLUMN			
MODEL	W	A	B
ICBIC-18FI	457 mm	64 mm	419 mm
ICBIC-24R, ICBIC-24FI	610 mm	102 mm	572 mm
ICBIC-30RID, ICBIC-30FI	762 mm	143 mm	724 mm
ICBIC-36RID	914 mm	184 mm	876 mm



SUB-ZERO INTEGRATED REFRIGERATION INTEGRATED MODELS

Overall Dimensions

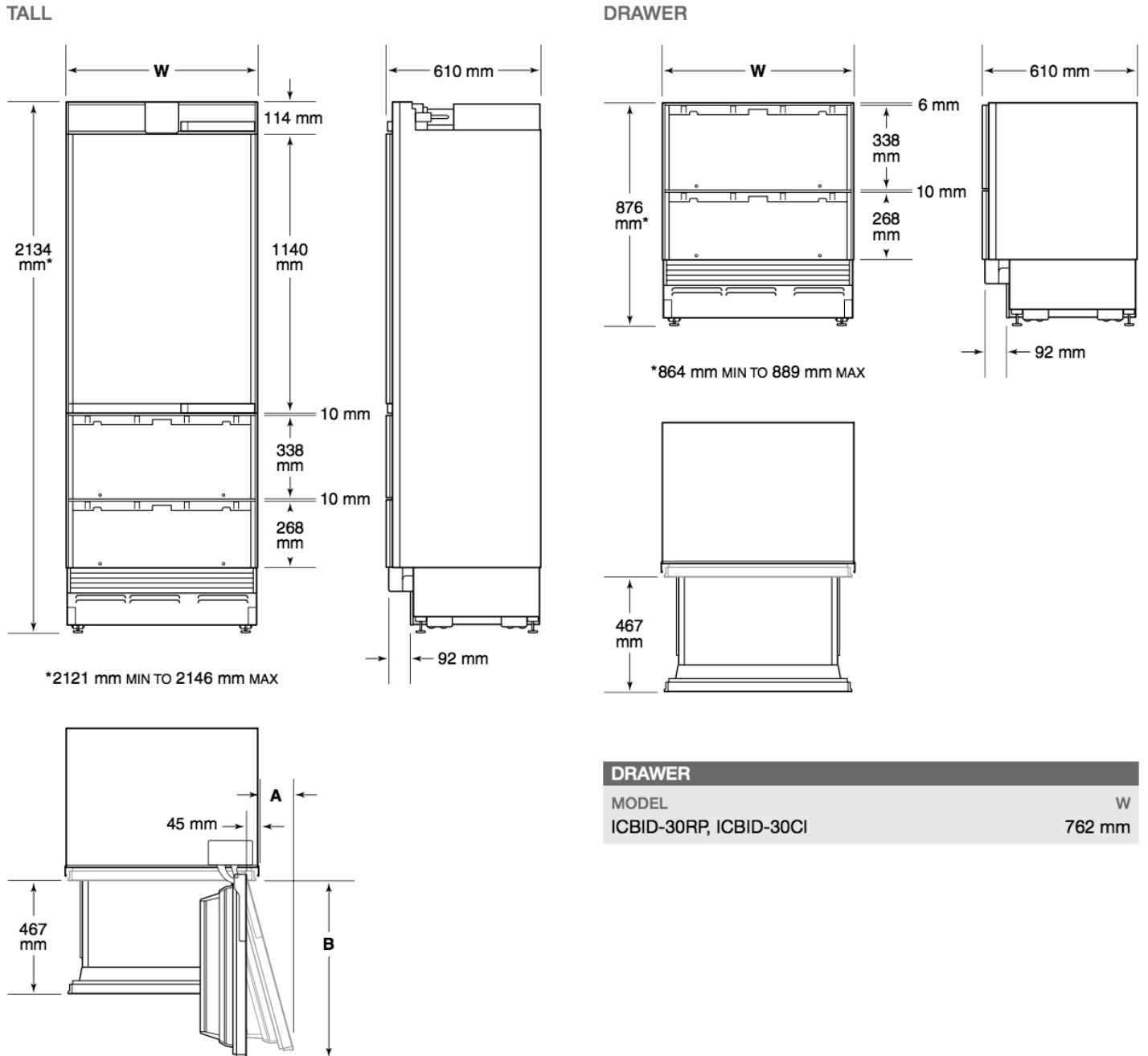

DRAWER	
MODEL	W
ICBID-30RP, ICBID-30CI	762 mm

TALL			
MODEL	W	A	B
ICBIT-30RID, ICBIT-30CIID	762 mm	143 mm	724 mm
ICBIT-36CIID	914 mm	184 mm	876 mm



SUB-ZERO INTEGRATED REFRIGERATION INTEGRATED MODELS

Custom Panels

For integrated models, custom door panels and handle hardware must be provided. Refer to the panel requirements chart and typical panel dimensions.

The thickness of the custom panel can vary. A minimum 16 mm thick panel is required, but the thickness can be increased provided it does not exceed the weight limit. The depth of each integrated model is 610 mm. Allow for panel thickness when planning the finished opening depth. Refer to the full-scale template on page 43.

⚠ CAUTION

As reveals between cabinetry and the unit decrease, severe finger pinching can occur while door is closing.

Finish all sides of custom panels. They will be visible when the door/drawer is open.

D-style handles are recommended. Door handles must be located near the edge of the panel opposite the hinge and should be centered top to bottom. Drawer handles must be located near the top edge of each panel. Stainless steel tubular and pro handles are available through an authorized Sub-Zero dealer.

TYPICAL PANEL DIMENSIONS

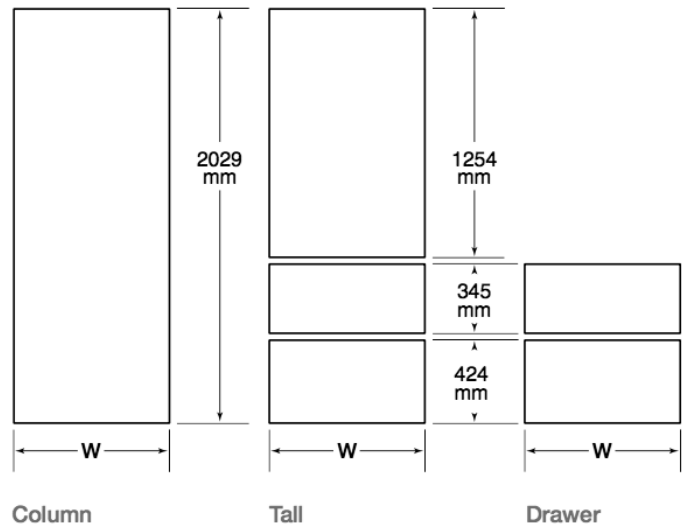

Typical panel dimensions are based on a 2134 mm finished height for column and tall models and 876 mm for drawer models, with a 102 mm toe kick and 3 mm reveals. Panel dimensions must be adjusted accordingly for all other installations. Refer to the illustration for panel heights and the chart below for panel widths.

PANEL REQUIREMENTS

COLUMN	MAX WEIGHT
457 mm Model	20 kg
610 mm Model	27 kg
762 mm / 914 mm Model	34 kg
TALL (DOOR)	MAX WEIGHT
762 mm Model	22 kg
914 mm Model	27 kg
DRAWER	MAX WEIGHT
Drawer Panel	7 kg
PANEL THICKNESS	MINIMUM
All Panels	16 mm

PANEL WIDTH

MODEL	W
457 mm Model	451 mm
610 mm Model	603 mm
762 mm Model	756 mm
914 mm Model	908 mm

DUAL INSTALLATION

For dual installations, refer to the illustration for panel heights and the chart below for panel widths.

PANEL WIDTH

MODEL	W
457 mm Model	452 mm
610 mm Model	605 mm
762 mm Model	757 mm
914 mm Model	910 mm



SUB-ZERO INTEGRATED REFRIGERATION INTEGRATED MODELS

Custom Panels

DOOR PANEL HEIGHT

The height of the custom door panel can extend beyond the typical panel height, provided it does not exceed the weight limit. Refer to the illustration below.

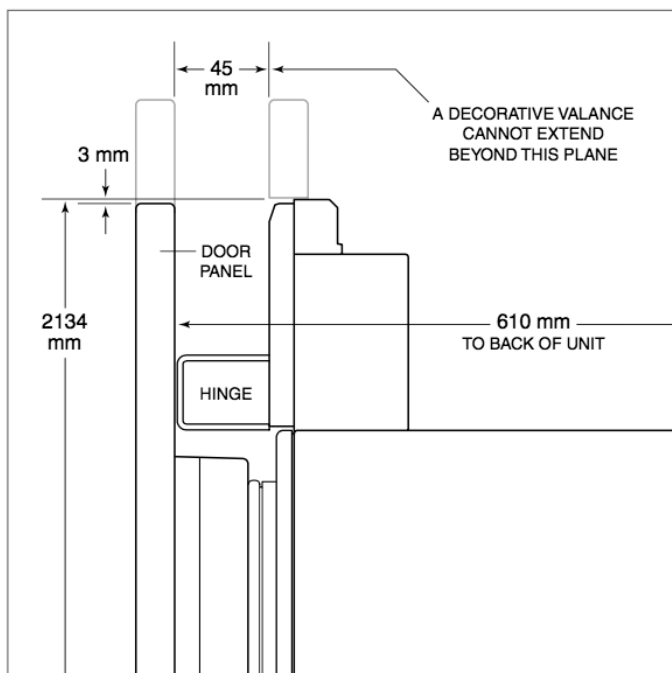

Upper valance—column and tall (side view).

TOE KICK CLEARANCE

The height of the toe kick area can extend beyond the typical toe kick height, provided it does not exceed the dimensions in the illustration below. Toe kick heights from 51 mm to 98 mm require a reduced toe kick accessory available through an authorized Sub-Zero dealer.

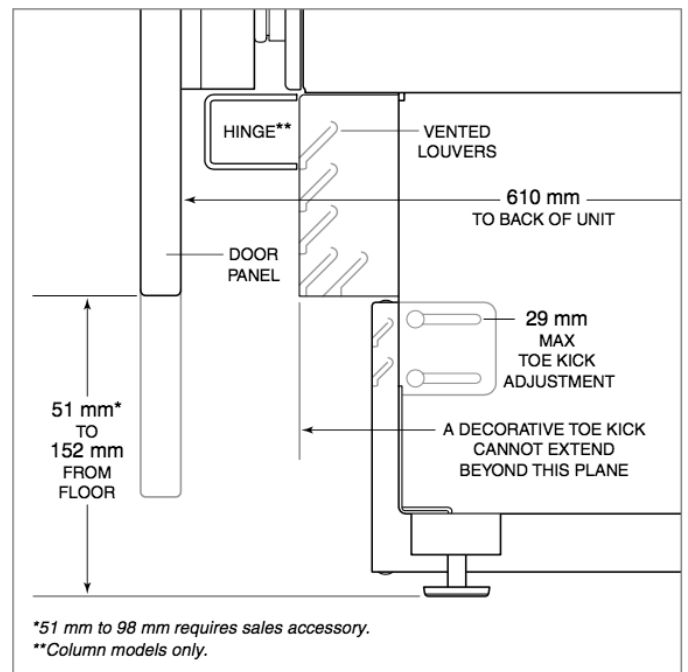

Toe kick (side view).

*51 mm to 98 mm requires sales accessory.
**Column models only.

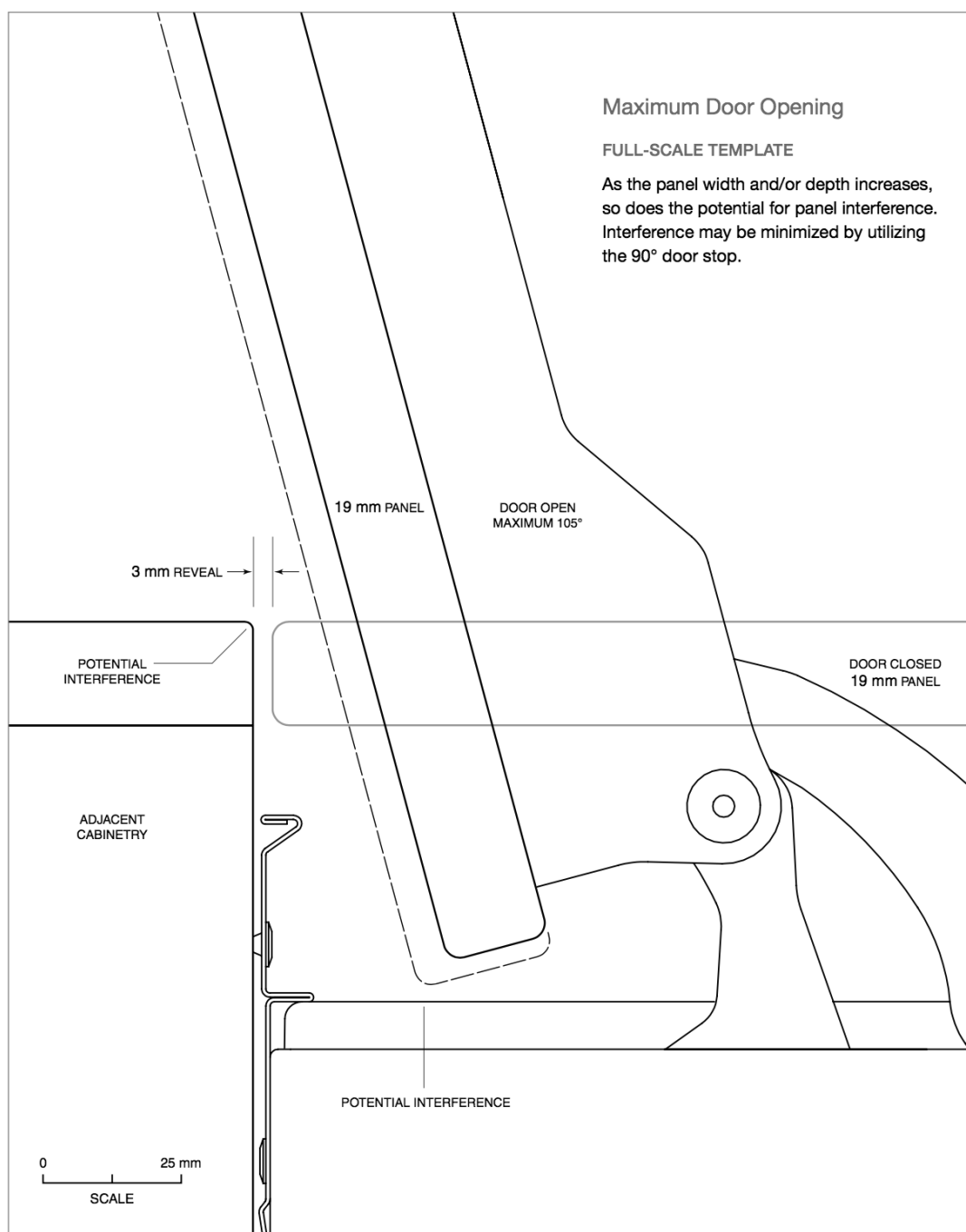

Standard Handles

Optional stainless steel tubular and pro handles are available through an authorized Sub-Zero dealer.

Refer to the chart below for standard handle lengths for integrated models.

HANDLE LENGTH		
INTEGRATED	TUBULAR	PRO
Column Door	1273 mm	1229 mm
Tall Door	845 mm	800 mm
762 mm Drawer	692 mm	648 mm
914 mm Drawer	845 mm	800 mm