

TRIPLE MOTOR DUCTING

I/I = Inside to Inside Measurement

NOTE:

This Zinc Alumne Strip is provided to join some duct pieces together. It will be clearly shown on the drawing of the piece it is supplied with.

**ROOF COWLS, WALL VENTS
AND WALL VENT COVERS**

SS = Stainless Steel

Ducting with the SS code is made in stainless steel type 445M2 which has a chromium content of 22% which is far greater than marine grade stainless steel and provides better protection.

SS = Stainless steel

CP = Colourbond OR Powderkote

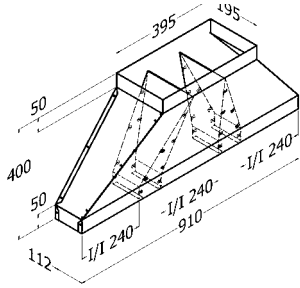

301. TMT-3 (Previously 3MT-DL-3)
Three Motor Transition to DL-3

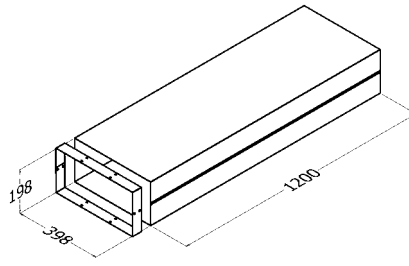

302. DL-3
DL-3 CP
Triple Motor Duct Length

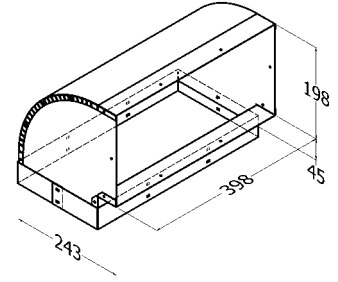

303. HB-3
Horizontal Bend Triple Motor 90°

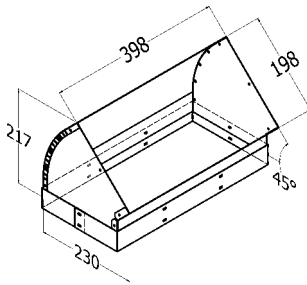

304. HB-3/45
Horizontal Bend Triple Motor 45°

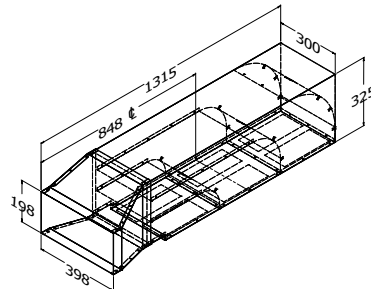

305. DD-DL-3 (Previously WCV S3)
Triple motor side duct outlet 300mm high

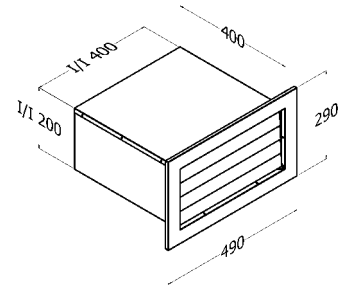

306. BD/WVH-3
BD/WVH-3 SS
Back Draft Wall Vent Triple Motor Horizontal

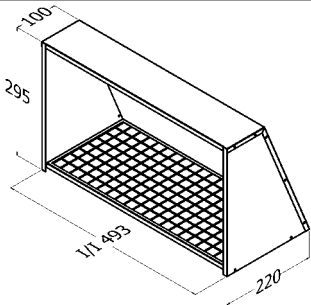

307. WVC-H-3
WVC-H-3 SS
Wall Vent Cover Triple Motor Horizontal

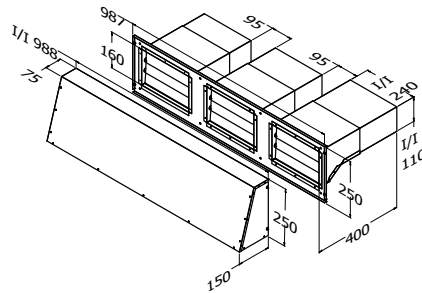

308. BD/WV/K-H-3
Kit assembled as one piece. Three Single Motor Back Draft Wall Vent Horizontal with telescopic length & cover.

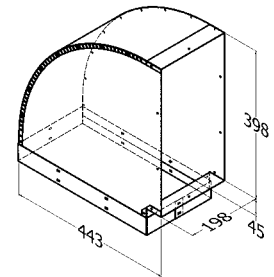

309. VB-3
Vertical Bend Triple Motor 90°

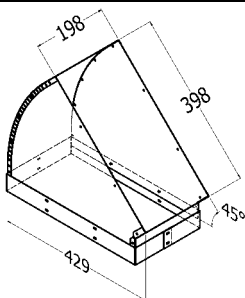

310. VB-3/45
Vertical Bend Triple Motor 45°

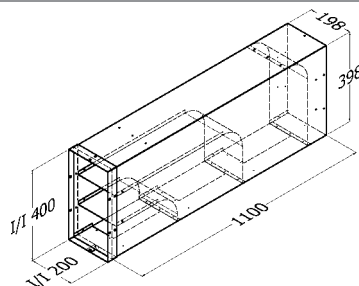

311. DD-3V-L
Duct Director Triple Motor Vertical Left

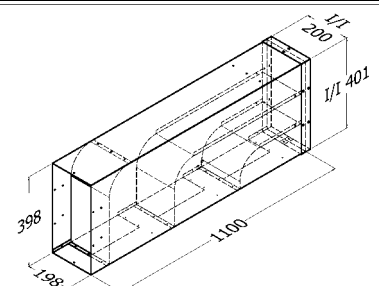

312. DD-3V-R
Duct Director Triple Motor Vertical Right

SS = Stainless steel

CP = Colourbond OR Powderkote

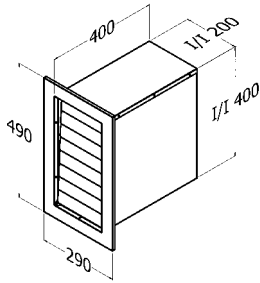

313. BD/WAV-3
BD/WAV-3 SS
Back Draft Wall Vent Triple Motor Vertical

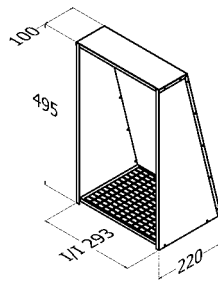

314. WVC-V-3
WVC-V-3 SS
Wall Vent Cover Triple Motor Vertical

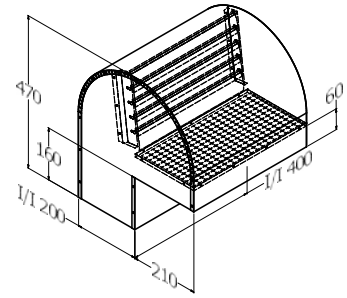

315. BD/RC-3
BD/RC-3 SS
BD/RC-3 CP
Back Draft Roof Cowl Triple Motor

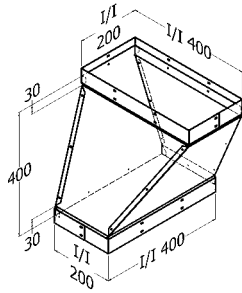

316. TT-3
Triple Motor Twisted Transition

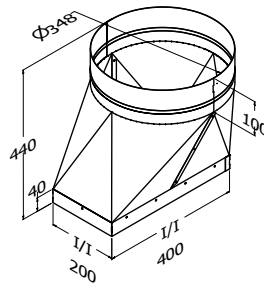

317. TR-3 (Previously TMT-400x200/350)
Triple Motor Transition DL-3 to 350ø

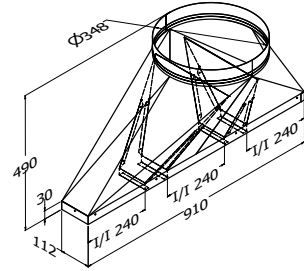

318. TMT-350 (Previously TR-3)
Triple Motor Transition to 350ø

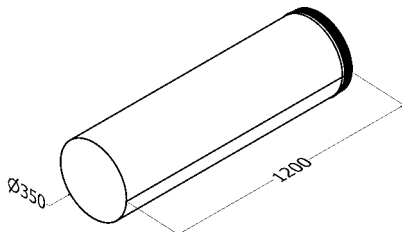

319. DR-350
DR-350 CP
Duct Length 350ø

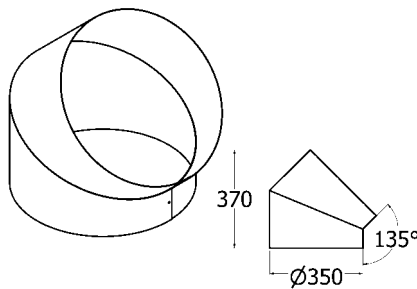

320. DR-350/45
350ø Bend 45°

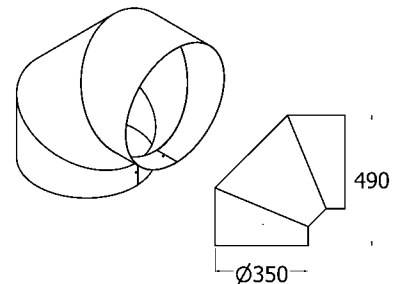

321. DR-350/90
350ø Bend 90°

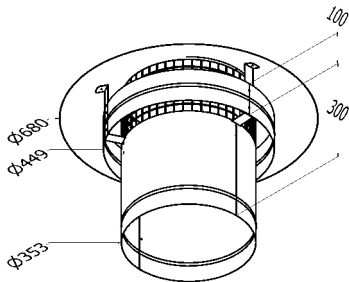

322. CH-350
CH-350 CP
Chairmans Hat 350ø

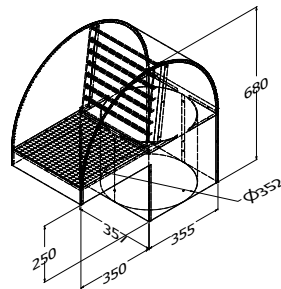

323. BD/SQ-RC 350
BD/SQ-RC 350 CP
Back Draft Roof Cowl Triple Motor 350SQ

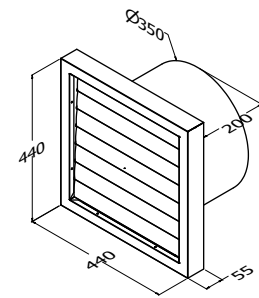

324. BD/WV-350
Back Draft Wall Vent Triple Motor 350ø

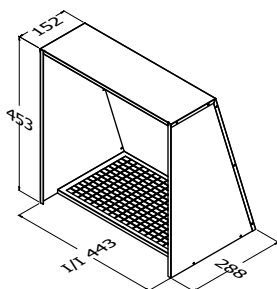

325. WVC-350
WVC-350 SS
Wall vent cover to suit single motor 350ø

14

TRIPLE MOTOR ▲