

TWIN MOTOR DUCTING

I/I = Inside to Inside Measurement

NOTE:

This Zinc Alume Strip is provided to join some duct pieces together. It will be clearly shown on the drawing of the piece it is supplied with.

ROOF COWLS, WALL VENTS AND WALL VENT COVERS

SS = Stainless Steel

Ducting with the SS code is made in stainless steel type 445M2 which has a chromium content of 22% which is far greater than marine grade stainless steel and provides better protection.

SS = Stainless steel

CP = Colourbond OR Powderkote

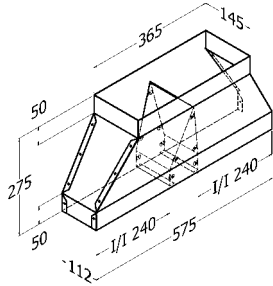

201. TMT-2 (Previously TMT)
Twin Motor Transition to DL-2

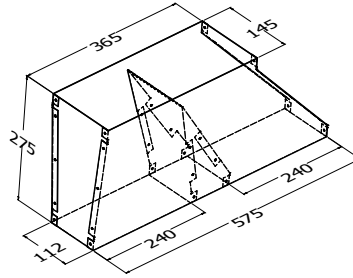

202. TMT-L/R
Twin Motor transition offset left or right to DL-2

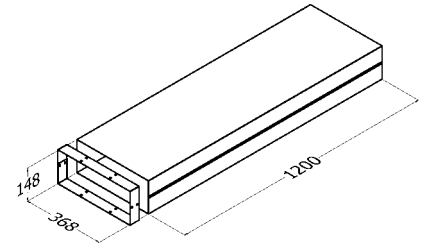

203. DL-2
DL-2 CP
Twin Motor Duct Length 1200mm

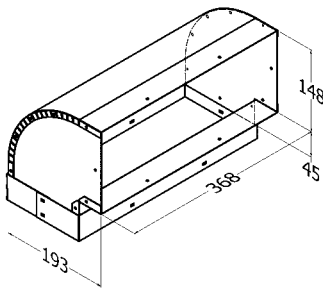

204. HB-2
Horizontal Bend Twin Motor 90°

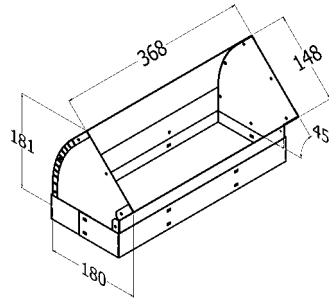

205. HB-2/45
Horizontal Bend Twin Motor 45°

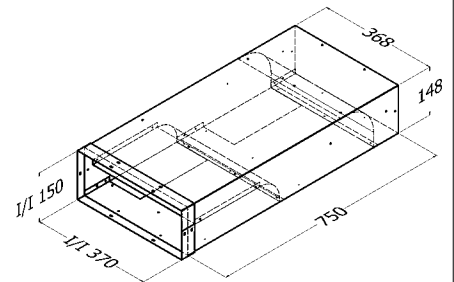

206. DD-2H-L
Duct Director Twin Motor Horizontal Left

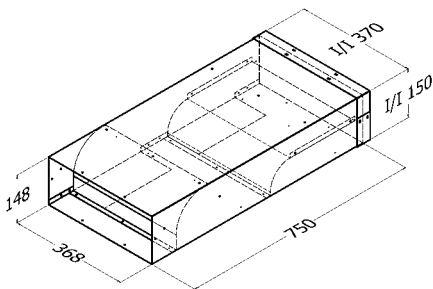

207. DD-2H-R
Duct Director Twin Motor Horizontal Right

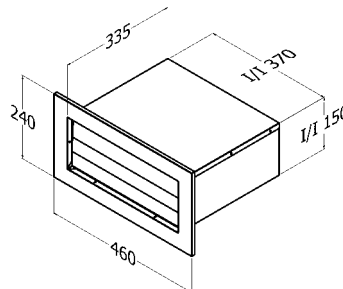

208. BD/WV-H-2
BD/WV-H-2 SS
Back Draft Wall Vent Twin Motor Horizontal

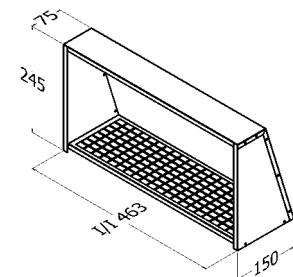

209. WVC-H-2
WVC-H-2 SS
Wall Vent Cover Twin Motor Horizontal

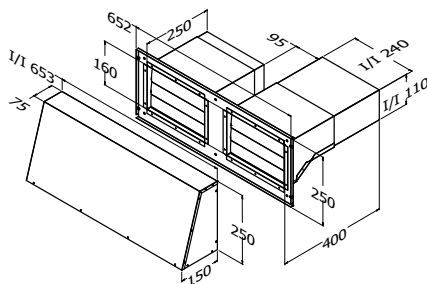

210. BD/WV/K-H-2
Kit assembled as one piece. Two Single Motor. Back Draft Wall Vent Horizontal with telescopic length & cover

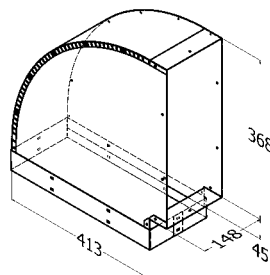

211. VB-2
Vertical Bend Twin Motor 90°

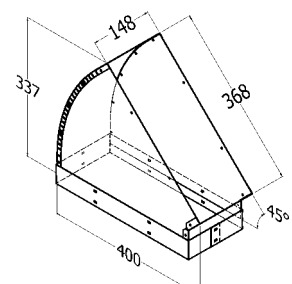

212. VB-2/45
Vertical Bend Twin Motor 45°

SS = Stainless steel

CP = Colourbond OR Powderkote

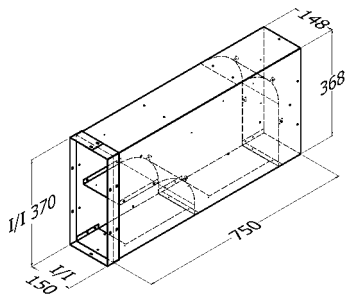

213. DD-2V-L
Duct Director Twin Motor Vertical Left

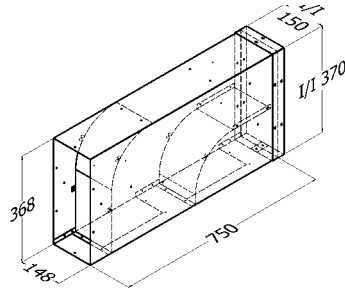

214. DD-2V-R
Duct Director Twin Motor Vertical Right

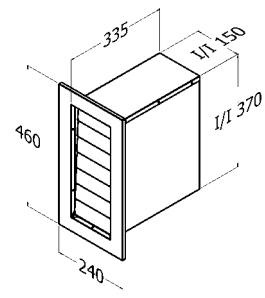

215. BD/WA-2
BD/WA-2 SS
Back Draft Wall Vent Twin Motor Vertical

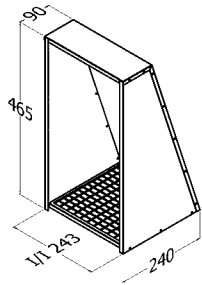

216. WVC-V-2
WVC-V-2 SS
Wall Vent Cover Twin Motor Vertical

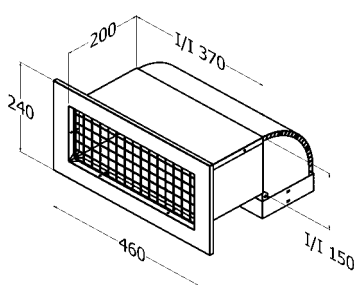

217. EV/DL-2
Eave Vent to Suit DL-2

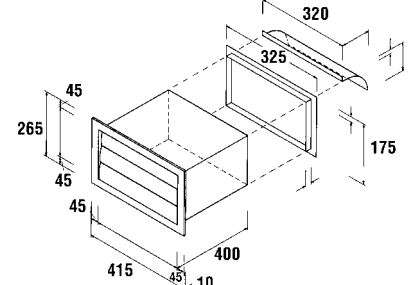

218. BD-10/12-WV-R/R
Back Draft Wall Vent 10/1200H

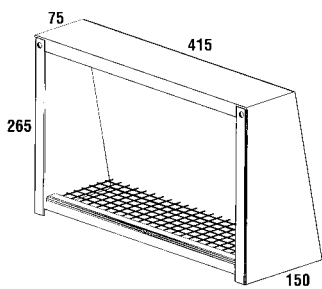

219. WVC-10/12H-R/R
Wall Vent Cover to suit 10/1200H

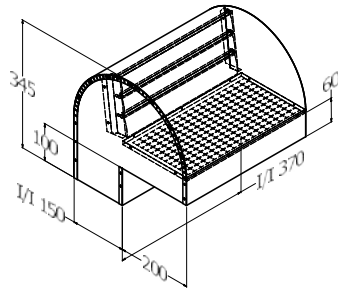

220. BD/RC-2
BD/RC-2 SS
BD/RC-2 CP
Back Draft Roof Cowl Twin Motor

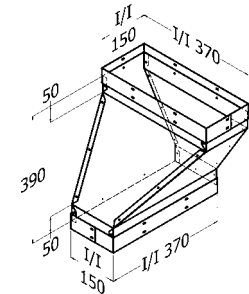

221. TT-2
Twisted Transition Twin Motor

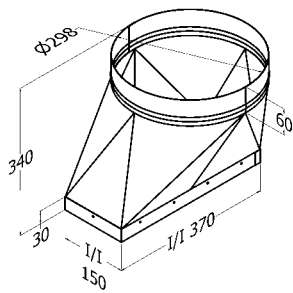

222. TR-2
Twin Motor Transition from DL-2 to 300ø

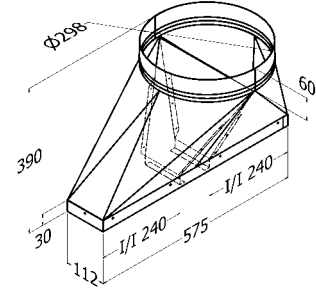

223. TMT-300
Twin Motor Transition to 300ø

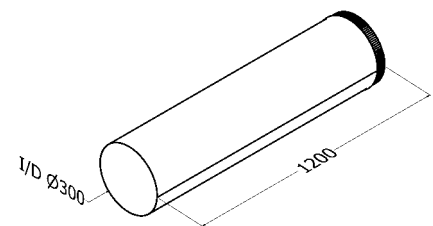

224. DR-300
DR-300 CP
Duct Length 300ø

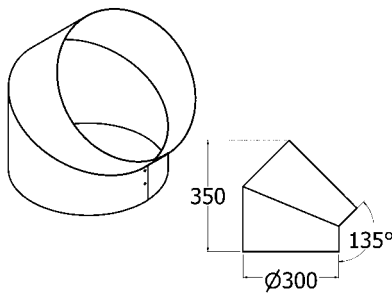

225. DR-300/45
300ø Bend 45°

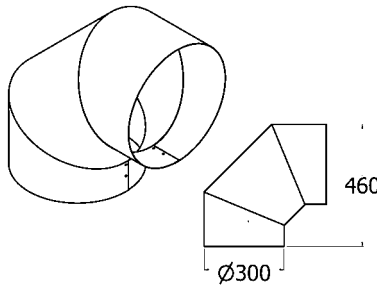

226. DR-300/90
300ø Bend 90°

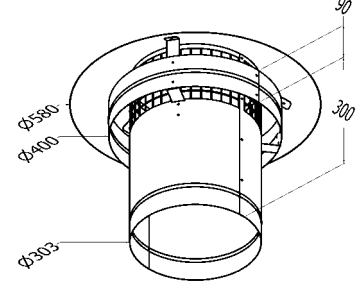

227. CH-300
CH-300 CP
Chairman's Hat 300ø

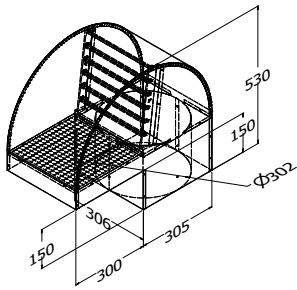

228. BD/SQ-RC 300
BD/SQ-RC 300 CP
Back Draft Roof Cowl 300ø

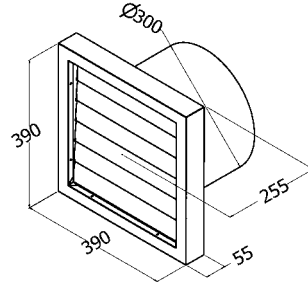

229. BD/WV-300
Back Draft Wall Vent 300ø

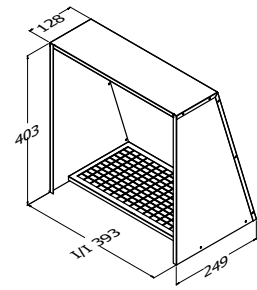

230. WVC-300
WVC-300 SS
Wall vent cover to suit single motor 300ø

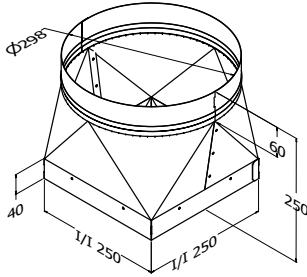

231. TR-250/300 (Previously TMT-250/300)
Twin Motor Transition 250Sø to 300ø

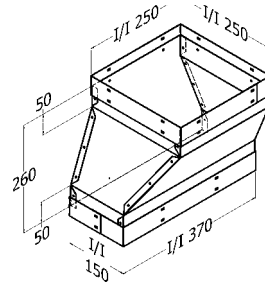

232. TR-DL-2/250SQ (Previously DL-2/250SQ)
Twin Motor Transition DL-2 to 250SQ

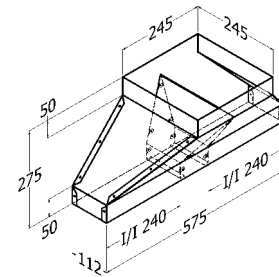

233. TMT-250
Twin Motor Transition to 250SQ

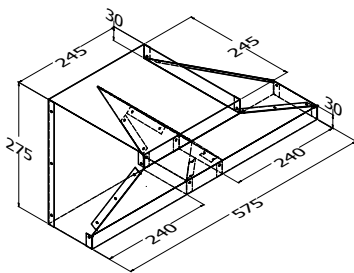

234. TMT-250 L
Twin Motor Transition to 250Sø offset left

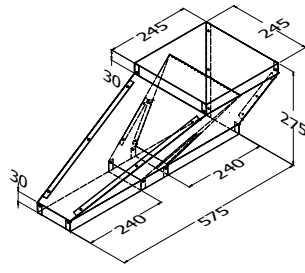

235. TMT-250 R
Twin Motor Transition to 250Sø offset right

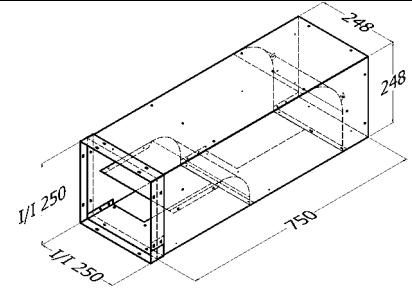

236. DD-250 L (Previously TMT-250/90 L)
Duct Deflector 250SQ Left

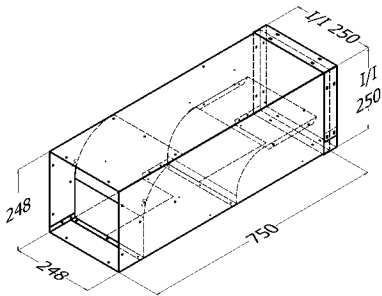

237. DD-250 R (Previously TMT-250/90 R)
Duct Deflector 250SQ Right

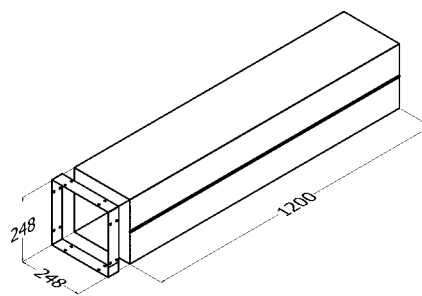

238. DL-250
DL-250 CP
Duct Length 250SQ

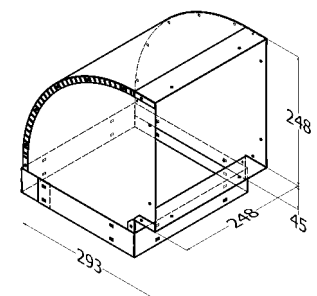

239. HB-250
Horizontal Bend 250SQ 90°

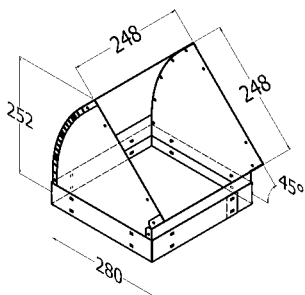

240. HB-250/45
Horizontal Bend 250SQ 45°

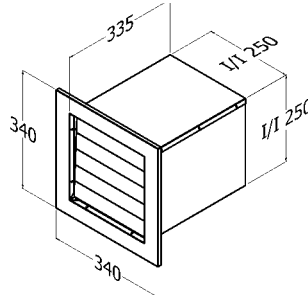

241. BD/WV-250 SQ
BD/WV-250 SQ SS
Back Draft Wall Vent 250SQ

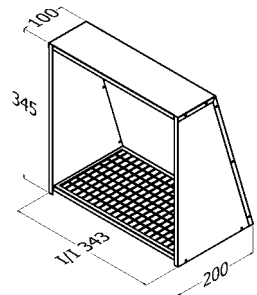

242. WVC-250 SQ
WVC-250 SQ SS
Wall Vent Cover 250SQ

SS = Stainless steel

CP = Colourbond OR Powderkote

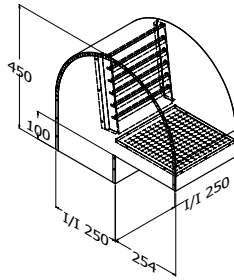

243. BD/RC-250 SQ
BD/RC-250 SQ CP
Wall Vent Cover 250SQ

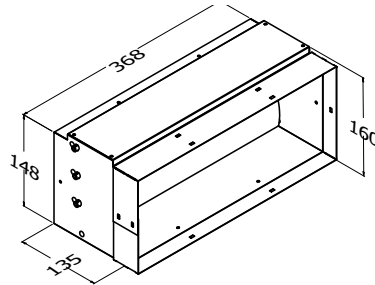

244. BD/D-2
Back Draft Damper Twin Motor DL-2

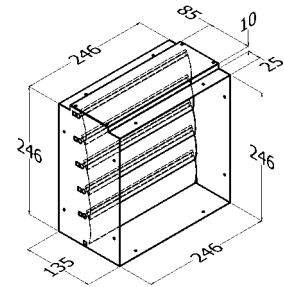

245. BD/D 250SQ (Previously BD/M-250SQ)
Back Draft Damper Twin Motor 250SQ

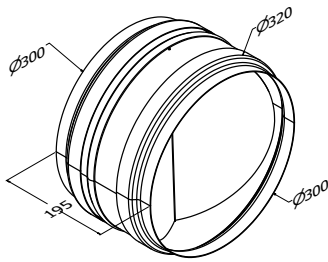

246. BD/D 300
Back Draft Damper Twin Motor 300ø

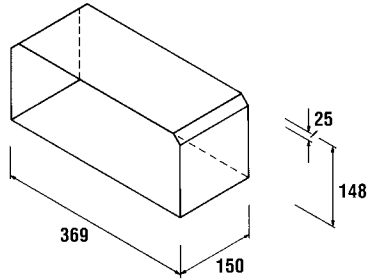

247. DLE-2 TO DLE-2
Flue Joiner Twin Motor

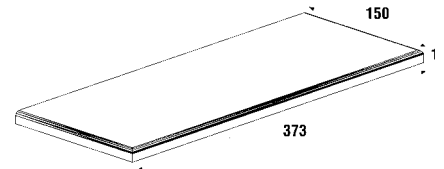

248. DLE-2-S/S CAP
Stainless Steel Flue Cap to Suit DLE-2

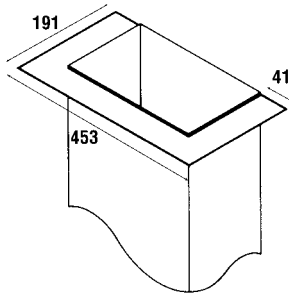

249. CF 10/1200H
Ceiling Flange to Suit 10/1200H

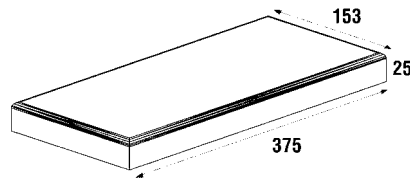

250. 10/12H-SC
Spigot Cap to Suit 10/1200H

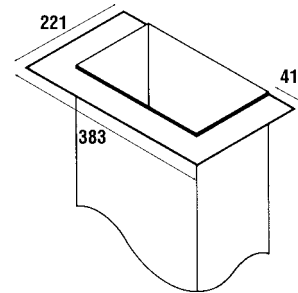

251. CF 3F-900-2
Ceiling Flange to Suit 3F 900-2

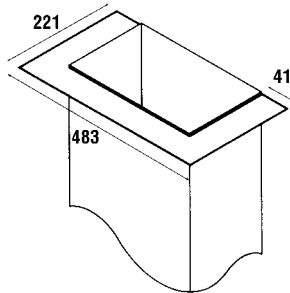

252. CF 3F-1200-2
Ceiling Flange to suit 3F 1200-2

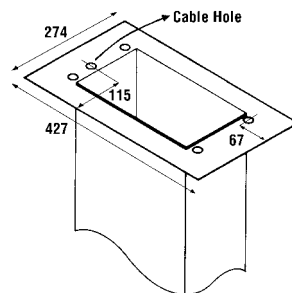

253. CF 4F-1000-2
Ceiling Flange to Suit 4F 1000-2

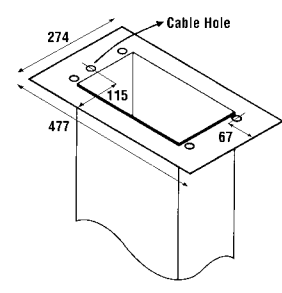

254. CF 4F-1200-2
Ceiling Flange to suit 4F 1200-2